



BACKER
CALESCO



ADAS STARTER KIT

FOIL HEATING INTRODUCTION

Introduction to foil heaters for ADAS applications

Our starter kit for the ADAS segment is an introduction to foil heaters for engineers and R&D departments that want to learn more or need heaters for a development project.

The starter kit includes 8 different heaters for 4 different applications that you can use for testing and development together with data sheets and useful information in order to find the right solution for your application.

Our solutions

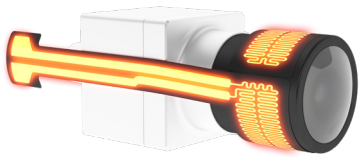

LENS HEATERS

Can be mounted either as a wrap around on the lens barrel, or in the very front around the lens. We want to have the heater as close to the lens as possible in order to achieve good performance and fast deicing of the lens to clear camera field of view.

FONT VIEW CAMERA HEATES

Commonly used for lane assist, collision warning, keeping distance to other vehicles etc.

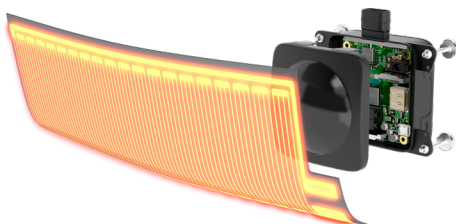

RADAR/ LIDAR HEATERS

Radar Heaters are needed in wet & snowy conditions. Defogging and deicing of the radar field of view minimizes incorrect readings, and avoid malfunction. Our constant wattage heater with minimal signal losses and great heating performance for a wide range of frequencies.



STARTER KIT - ADAS

Specifications - For heaters included in the starter kit

CAMERA HEATERS

Part No.	Voltage	Wattage	Heated area (cm ²)	W/cm ²	Material
PO109312-00	12	9	15,63	0,59	Polyester
PO109313-00	12	9	25,46	0,35	Polyester
PO109314-00	12	19,8	56,23	0,35	Polyester

RADAR HEATERS

Part No.	Voltage	Wattage	Heated area (cm ²)	W/cm ²	Material
PO109307-00	12	16,3	66	0,24	Polyester
PO109308-00	12	24	66	0,36	Polyester

LENS HEATERS

Part No.	Voltage	Wattage	Heated area (cm ²)	W/cm ²	Material
PI109309-00	12	3	3,58	0,79	Polyimide
PI109310-00	12	1,43	2,89	0,5	Polyimide

LIDAR HEATERS

Part No.	Voltage	Wattage	Heated area (cm ²)	W/cm ²	Material
PO109311-00	12	9,19	23,2	0,4	Polyester

OT109336-00

Rev No:	Revision note, Calesco Foil	Project	Date	Signature

This drawing must not without our permission be copied, shown to a third part or otherwise be used unauthorized. Offenders will be prosecuted according to law in force BACKER BHV AB.

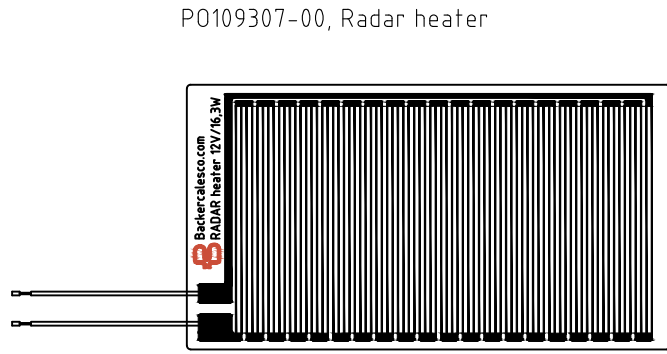

P0109307-00, Radar heater

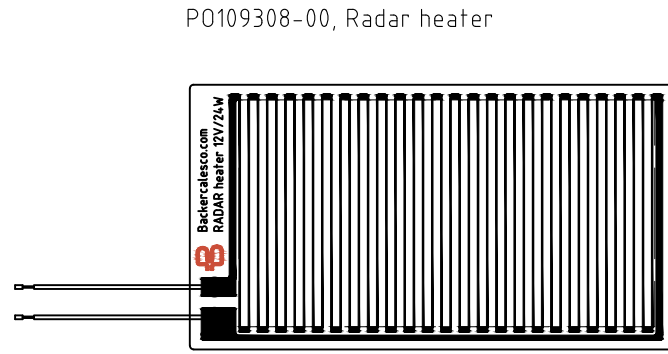

P0109308-00, Radar heater

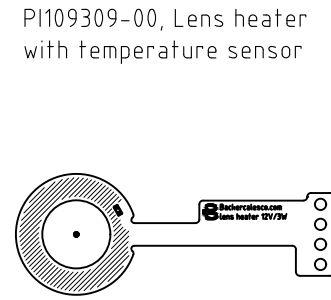

P1109309-00, Lens heater with temperature sensor

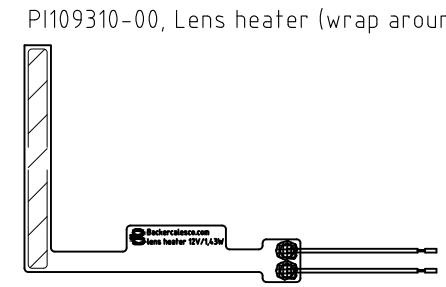

P1109310-00, Lens heater (wrap around)

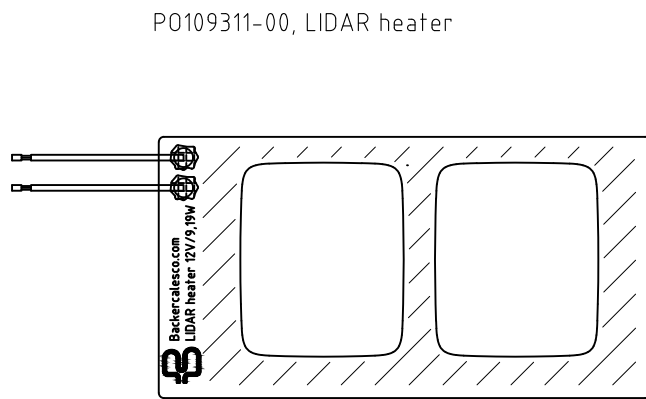

P0109311-00, LIDAR heater

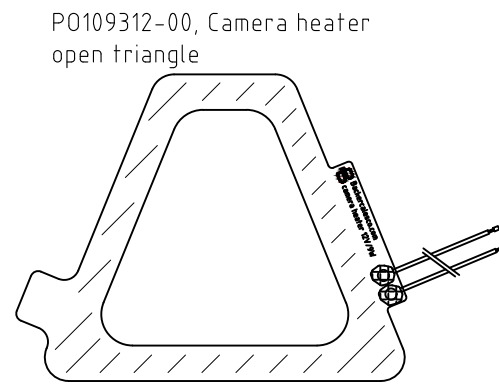

P0109312-00, Camera heater open triangle

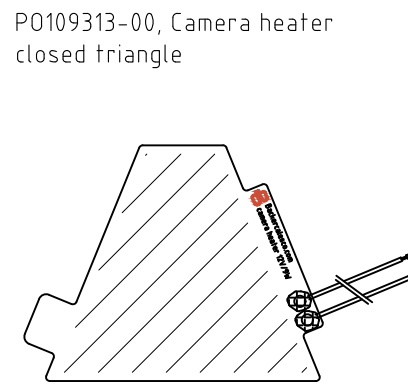

P0109313-00, Camera heater closed triangle

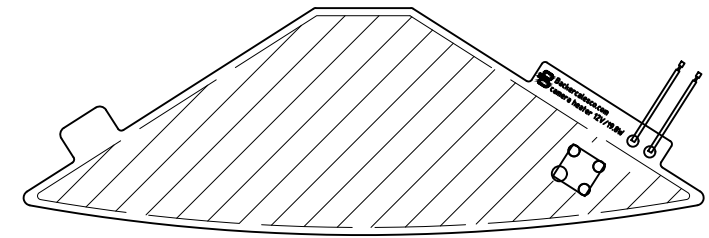

P0109314-00, Camera heater with controller unit

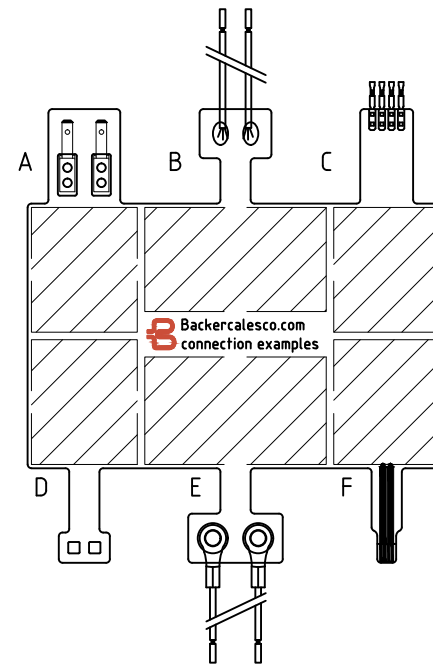

P0109315-00, Connection methods

Designed by AC	Checked by RP	Mfg approved by - date	General tolerance ISO 2768 - C	Part number OT109336-00	Date 2022-01-12	Scale 1:2
First angle projection 		Title ADAS starter kits			Size A4	
All measures in mm			Drawing No.	Rev 00	Project	



Calculation of power

The following information will assist in the design of elements and rough calculation of data. Optimum power and temperature conditions for specific applications are usually determined experimentally.

The following formula can be used to determine approximately the required rating P (Power) to heat a given material.

$$P = \frac{\text{Weight of material (g)} \times \text{Spec.heat (Ws/g } ^\circ\text{C)} \times \text{temp. rise } ^\circ\text{C}}{\text{Time sec}} \quad \text{W}$$

Technical specification

Spec. heat and density of common materials:

Material	Spec. heat Ws/g	Density g/cm ³
Aluminum	0.90	2.7
Copper	0.39	8.9
Stainless steel	0.50	8.0
Iron	0.46	7.8
Water	4.18	1.0

Temperature control

In conjunction with CALESCO foil heating elements it is usually necessary to arrange some form of control to ensure that the desired temperature is maintained.

This can be achieved with electromechanical thermostats of bimetallic type where temperatures and surface ratings are low, while electronic thermostats are preferred where temperatures and surface loads are high.

We can fit thermostats, temperature fuses and sensors of the thermoelement type, thermistors and resistance sensors directly to element in accordance with customer specifications.

Electrical insulation and leakage current

When a foil element is fitted on or in contact with a metal, surface leakage current must be taken into account. The basic standard for heating appliances is laid down in the rules IEC 335-1, on which various national standards are based.

The maximum level of leakage current for Class I (earthed) appliances is 0.75 mA/kW while for Class II (double-insulated) appliances it is 0.25 mA/kW. Medical appliances are subjected to special leakage current restrictions as per IEC 601.



Product photo

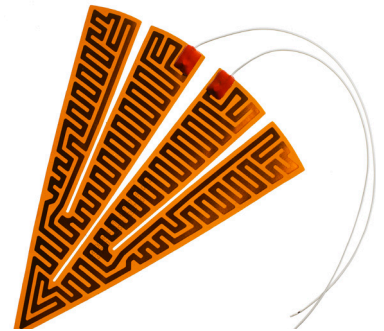

Temperature curves and required power

The diagrams below show temperature rise as a function of time for certain applications and various types of element with different surface rating. Surface rating is defined as the total power divided by the effective area of one side of the element.

Optimum power and temperature conditions for specific applications are usually determined experimentally.

Temperature rise for element mounted on aluminium

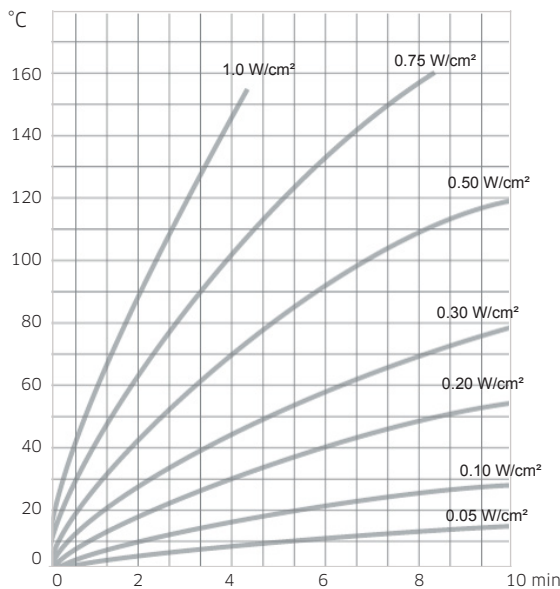

Watt density W/cm²	0.05	0.10	0.20	0.30	0.50
Final temp. rise °C	25	45	80	105	160

Foil element mounted on an aluminium plate, 215x155x5 mm, with adhesive and suspended horizontally in free air.

Temperature rise for element alone

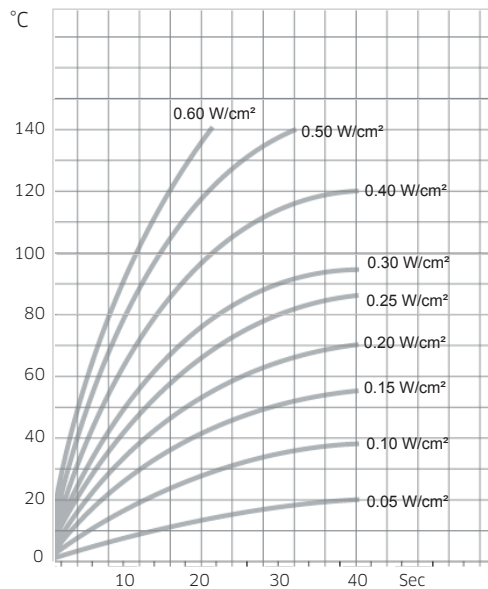

Watt density W/cm²	0.05	0.10	0.15	0.20	0.25	0.30	0.40	0.50	0.60
Final temp. rise °C	25	45	60	80	90	105	130	160	175

Foil element, 210x150 mm, suspended horizontally in free air.

Benefits

- Space saver
- Optimized heat distribution
- High/Low wattage
- Custom design
- Cost efficient

Description

The etched heating element has superior heat transfer and exceptionally uniform heat output, which results in a faster warm-up cycle and longer life. Use this heater to cover large areas with even heat, for flat or gently curved surfaces. Etched foil polyester heaters can be designed and fabricated in many types of configurations to fit the size and shape required in your application.

Technical specification

Max element temp.	130 °C (266 °F)
Min. element temp.	-60°C (-76°F)
Dielectric strength at 20°C AS per ASTM KV/mm	175
Thermal conductivity at 100 °C W/(m•K)	0.16
Moisture absorption as per ASTM D-570-63. (24h immersion at 23°C)	0.8%
Waterproof as per IEC 335-1 sect. 15-16	yes
Constant of dielectricity at 25°C, 50Hz	3.3
Bending radius, min	1 mm
Max. element width	610 mm
Power density	0,6 W/cm ²
Resistance tolerance	As standard, ±5% of nominal. Tolerance down to ±2% available
Rated voltage	Up to 1000 V AC/DC single or 3 phase

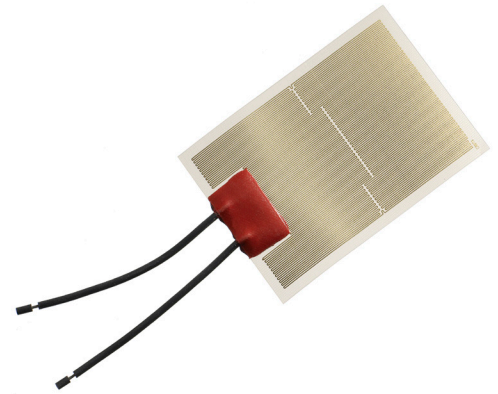

Product photo

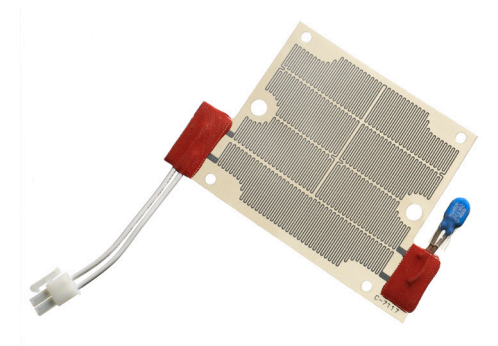

Benefits & Fields of Application

BENEFITS

- Low wattage
- Distributed wattage
- Edge loss compensation
- Very small sizes of heaters can be precizely manufactured
- Economical mass production
- Accurate reproduction of complex circuits

FIELDS OF APPLICATION

- Bathroom mirror heater
- De-icing equipment
- Rear view mirror
- Hand grip heater



Application photo



BACKER
CALESCO

POLYIMIDE HEATERS

Description

Polyimide is a thin, semitransparent material with excellent dielectric strength. It is also resistant to most chemicals, acid and basis. The temperature range is between as low as -271°C (liquid helium) and as high as 200°C. If requested we have the possibility to add components such as thermistors, sensors and IC circuits, by soldering them to the element.

Technical specification

Max element temp.	200 °C (392 °F)
Min. element temp.	-271 °C (-456 °F)
Dielectric strength at 20°C AS per ASTM KV/mm	205
Thermal conductivity at 100 °C W/(m•K)	0.12
Moisture absorption as per ASTM D-570-63. (24h immersion at 23°C)	2.8 %
Waterproof as per IEC 335-1 sect. 15-16	No
Constant of dielectricity at 25°C, 50Hz	3.5
Bending radius, min	1 mm
Max. element width	610 mm
Power density	1,3 W/cm ²
Resistance tolerance	As standard, ±5% of nominal. Tolerance down to ±2% available
Rated voltage	Up to 1000 V AC/DC single or 3 phase



Product photo



Benefits & Fields of Application

BENEFITS

- High and low temperature range
- Excellent dielectric strength
- Good chemical resistance
- Soldered components possible

FIELDS OF APPLICATION

- Military/aerospace, where low outgassing properties are required
- Medical diagnostic instruments, where autoclave cleaning or sterilization is needed
- Photographic equipment
- LCD displays
- Laboratory research



Application photo

ASSEMBLY INSTRUCTIONS

1. Adhesive

If the release paper does not come off, or tears, the element should NOT be used. If this happens the element must be scrapped. There can be small bubbles or wrinkles in release liner, making the surface of the adhesive look slightly different (stains, marks...). This is only visual effect and does not impact the adhesion.

- Surface tension should be above 38 Dynes/cm². If surface energy is below 38 Dynes/cm² we recommend cleaning with alcohol, isopropanol or corona treatment.
- The maximum adhesion is reached 72 h after assembly. Any usage or testing of performance is therefore made more than 24 h after assembly.

2. Packaging & Storage

Change of packaging is not recommended, since it can create creases, folds and terminal damage if heaters are not handled with care. If however repackaging the parts for production reasons is done, heaters should be placed flat.

Optimal Storage for heaters is at a temperature of 21°C, with 50% RH

Life time of heaters:

If stored in closed cartons, in optimal conditions as above, storage time of heaters can be at least 36 months without any damage. If heater exceeds this time limit, we recommend a pull-force test of the heater on a sub-assembly to verify adhesion. Our experience shows that the adhesive is still performing as in initial conditions.

Warranty time:

Standard warranty time is 24 months from deliver date, unless specific agreements.

3. Assembling recommendations

How to proceed:

It is of utmost importance that proper training exists for the team members assembling the heater sub assembly.

- Remove release liner on the first side to be mounted
- Avoid touching the surface of adhesive with hands or clothes
- Position element to surface, press smoothly to avoid creation of air pockets or air bubbles (can cause over heating and lower adhesion performance)
- Remove release liner on second side of elements, if applicable
- Avoid touching surface of adhesive with hands or clothes
- Press sub-assembly in appropriate fixture, with an evenly distributed force over the whole surface of glass and back plate, if applicable
- Force on element should be approximately 1km/cm² for min 10 seconds

ASSEMBLY INSTRUCTIONS

If heater is misplaced or miss-aligned during assembling:

- DO NOT CUT heater to allow air out of assembly
- DO NOT try to re-assemble, due to risk of circuit damage (heater is to be scrapped)
- DO NOT cut around the part (circuit will be damaged)

4. Curing time after assembly

All adhesives used today by Backer are pressure sensitive adhesives, and need activation and polymerization to reach their full performance, we recommend to let the heater cure for 24 hours at RT. We strongly advice not to perform any pull test on glass during the first hour of assebly, this can cause a stoppage in the curing process of the adhesives and create later openings.

5. Testing after assembling

No testing of the adhesion should be performed until the assembly has cured for at least for 24 hours. Full curing is achieved after 72 hours. This guideline is provided for your information, it is not exhaustive, and can be modified at any time by our company.

6. Important recommendations

The information provided in this document is correct to the best of our knowledge.

Each product we manufacture has been developed carefully. However, experience has shown that for each product and application, the requirements may differ from case to case. We therefore recommend that you carry out your own test to verify that the mounting is done to provide best results. All information is given in good faith, based on tests, but without guarantee.



Customised solutions

Customers often come to us with an idea about a new project/solution, a need for our expertise or because they want to enter a partnership with us. We are more than happy to share our facilities, vast experience and expertise at this initial stage. The earlier we are involved in a project, the more we can control the optimisation of core issues, such as the choice of materials, components and technology, temperature control, energy consumption and sustainability, cost efficiency and compliance with all applicable norms, regulations and standards.





Backer AB / Div. Calesco
Västra Ävågen 11
SE-734 51 Kolbäck, Sweden
Tel: +46 (0) 220 453 00

backercalesco.com

EVERYDAY · EVERYWHERE